

# E-2E User Guide

---

## Phono Equalizer Amplifier

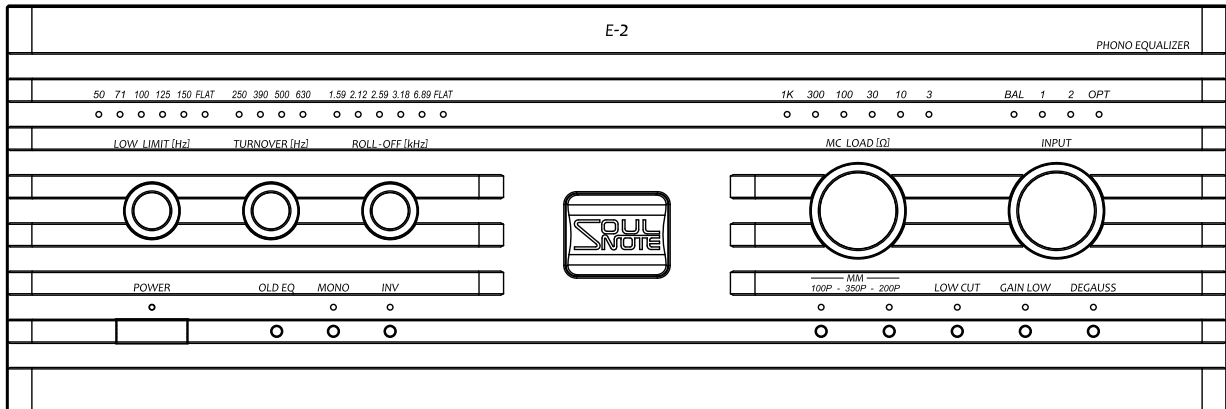

## Table of Contents

Safety Precautions.....	3
Front Panel Names and Functions .....	6
Rear Panel Names and Functions.....	8
About EQ Curves of Old Records.....	9
Balanced Input/Output.....	13
Attaching the Spike Pins.....	13
Aging.....	13
Troubleshooting .....	14
Maintenance .....	14
Specifications.....	14

### Supplied Accessories

• User Guide (this manual) .....	1
• Power cable .....	1
• Spike pin .....	3
• Wrench (Spanner).....	1
• EQ curve label.....	1

## Safety Precautions



### CAUTION

RISK OF ELECTRIC SHOCK  
DO NOT OPEN



CAUTION: TO REDUCE THE RISK OF ELECTRIC SHOCK, DO NOT REMOVE COVER (OR BACK). NO USER-SERVICEABLE PARTS INSIDE. REFER SERVICING TO QUALIFIED SERVICE PERSONNEL.



The lightning flash with arrowhead symbol, within an equilateral triangle, is intended to alert the user to the presence of uninsulated “dangerous voltage” within the product’s enclosure that may be of sufficient magnitude to constitute a risk of electric shock to persons.



The exclamation point within an equilateral triangle is intended to alert the user to the presence of important operating and maintenance (servicing) instructions in the literature accompanying the product.

### WARNING

TO REDUCE THE RISK OF FIRE OR ELECTRIC SHOCK, DO NOT EXPOSE THIS APPLIANCE TO RAIN OR MOISTURE.

A warning that an apparatus with CLASS I construction shall be connected to a MAINS socket outlet with a protective earthing connection.

**IMPORTANT SAFETY INSTRUCTIONS**  
**READ BEFORE OPERATING EQUIPMENT**

This product was designed and manufactured to meet strict quality and safety standards. There are, however, some installation and operation precautions which you should be particularly aware of.

1. Read these instructions.
2. Keep these instructions.
3. Heed all warnings.
4. Follow all instructions.
5. Do not use this apparatus near water.
6. Clean only with dry cloth.
7. Do not block any ventilation openings.  
Install in accordance with the manufacturer's instructions.
8. Do not install near any heat sources such as radiators, heat registers, stoves, or other apparatus (including amplifiers) that produce heat.
9. Protect the power cord from being walked on or pinched particularly at plugs, convenience receptacles, and the point where they exit from the apparatus.
10. Only use attachments/accessories specified by the manufacturer.
11. Use only with the cart, stand, tripod, bracket, or table specified by the manufacturer, or sold with the apparatus. When a cart is used, use caution when moving the cart/apparatus combination to avoid injury from tip-over.
12. Unplug this apparatus during lightning storms or when unused for long periods of time.
13. Refer all servicing to qualified service personnel. Servicing is required when the apparatus has been damaged in any way, such as power-supply cord or plug is damaged, liquid has been spilled or objects have fallen into the apparatus, the apparatus has been exposed to rain or moisture, does not operate normally, or has been dropped.
14. Batteries shall not be exposed to excessive heat such as sunshine, fire or the like.



**CAUTION:**

- To completely disconnect this product from the mains, disconnect the plug from the wall socket outlet. The mains plug is used to completely interrupt the power supply to the unit and must be within easy access by the user.
- Never use the unit with any other cord except the supplied power cord.

**NOTE ON USE**

<b>WARNINGS</b>
<ul style="list-style-type: none"><li>• Avoid high temperatures. Allow for sufficient heat dispersion when installed in a rack.</li><li>• Handle the power cord carefully. Hold the plug when unplugging the cord.</li><li>• Keep the unit free from moisture, water, and dust.</li><li>• Unplug the power cord when not using the unit for long periods of time.</li><li>• Do not obstruct the ventilation holes.</li><li>• Do not let foreign objects into the unit.</li><li>• Do not let insecticides, benzene, and thinner come in contact with the unit.</li><li>• Never disassemble or modify the unit in any way.</li><li>• Ventilation should not be impeded by covering the ventilation openings with items, such as newspapers, tablecloths or curtains.</li><li>• Naked flame sources such as lighted candles should not be placed on the unit.</li><li>• Observe and follow local regulations regarding battery disposal.</li><li>• Do not expose the unit to dripping or splashing fluids.</li><li>• Do not place objects filled with liquids, such as vases, on the unit.</li><li>• Do not handle the mains cord with wet hands.</li><li>• When the switch is in the OFF position, the equipment is not completely switched off from MAINS.</li><li>• The equipment shall be installed near the power supply so that the power supply is easily accessible.</li></ul>

### DECLARATION OF CONFORMITY

We declare under our sole responsibility that this product, to which this declaration relates, is in conformity with the following standards:

EN60065, EN55032, EN55020.

Following the provisions of Low Voltage Directive 2014/35/EU and EMC Directive 2014/30/EU.

### A NOTE ABOUT RECYCLING:

This product's packaging materials are recyclable and can be reused. Please dispose of any materials in accordance with the local recycling regulations. When discarding the unit, comply with local rules or regulations.

Batteries should never be thrown away or incinerated but disposed of in accordance with the local regulations concerning battery disposal. This product and the supplied accessories, excluding the batteries, constitute the applicable product according to the WEEE directive.



Pb

### CAUTIONS ON INSTALLATION

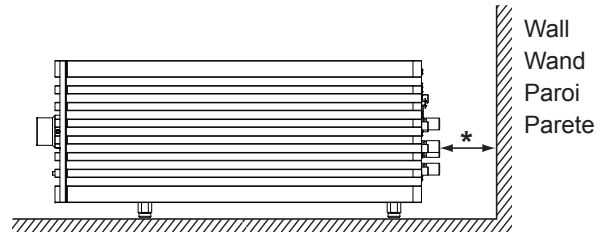
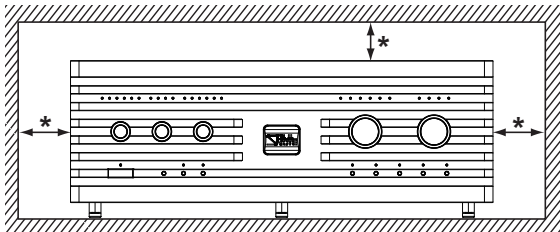

**\* For proper heat dispersal, do not install this unit in a confined space, such as a bookcase or similar enclosure.**

- Leave sufficient clearance (at least 10 cm) from the wall, (at least 5 cm) from top surface of the unit.
- Do not place any other equipment on this unit.

# Front Panel Names and Functions

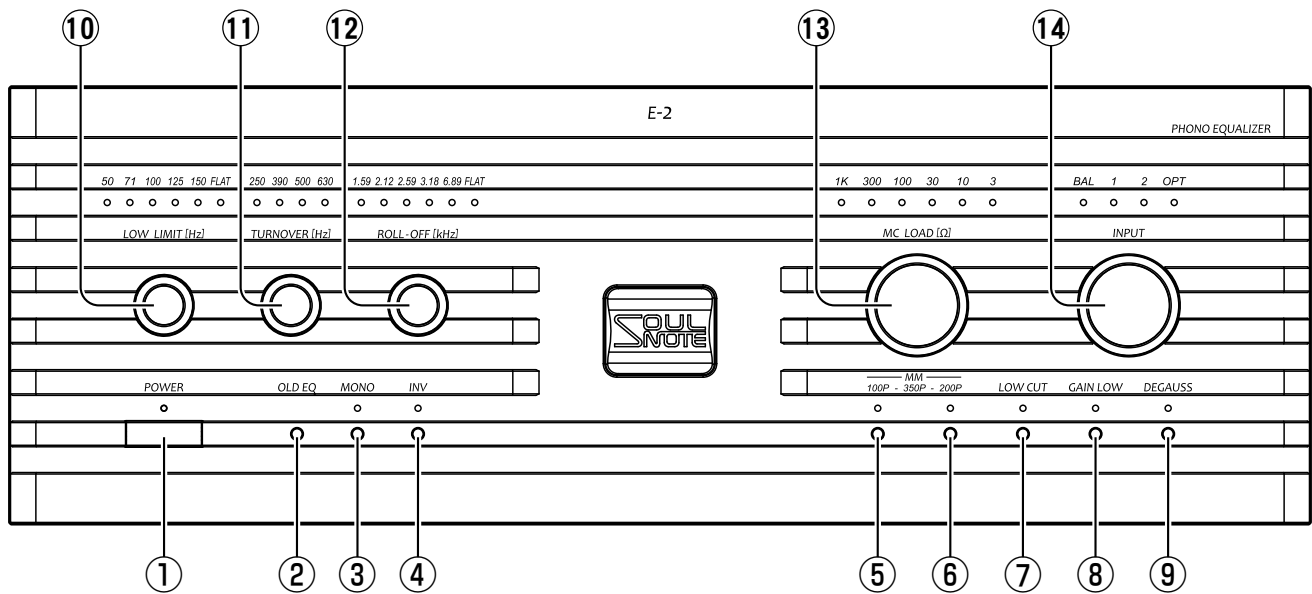

## ① Power Switch (POWER)

Press to turn on the power, and press again to turn off. The switch returns to the same position whether the power is turned on or off. About 5 seconds is required for sound to be output after turning on the power. When the power is turned on, the LED lights up. When the Input Selector Dial is set to “BAL”, “1”, or “2”, the LED lights up in red, and when the Input Selector Dial is set to “OPT”, the LED lights up in blue.

## ② Old Equalizer Button (OLD EQ)

When this button is pressed, the EQ parameter LEDs light up enabling you to change the old EQ curve settings by using the Frequency Selector Dials ⑩, ⑪, and ⑫. Press again to cancel the settings. The button operation is disabled when OPT is selected. About 5 seconds is required for sound to be output after the button operation. This function is intended to be used when playing an original LP record or SP record created before the EQ curve standard was unified to RIAA. For details, see “About EQ Curves of Old Records”.

## ③ Mono Audio Button (MONO)

When this button is pressed, the LED lights up. The right and left output channels are synthesized for a mono audio output. Press again to disable mono.

## ④ Phase Inversion Button (INV)

When this button is pressed, the LED lights up inverting output phase. Press again to cancel the phase inversion.

## ⑤,⑥ MM Buttons (MM 100P-350P-200P)

When the button(s) are pressed, the corresponding LED(s) light up switching to the MM position. Press again to cancel the MM position. The button operation is enabled when the input is set to “1”, or “2”. The load capacitance optimal for the MM cartridge used can also be selected. About 5 seconds is required for sound to be output after the button operation.

- ⑤ Load resistance 47 kohm, Load capacitance 100PF
- ⑥ Load resistance 47 kohm, Load capacitance 200PF
- ⑤+⑥ Load resistance 47 kohm, Load capacitance 350PF

### Note:

- To adjust the load capacitance to the suitable load capacitance of the cartridge, add the phono cable capacitance. The phono cable capacitance is generally approx. 100PF. For example, when the suitable load capacitance of the cartridge is 450PF and the phono cable capacitance is 100PF, select the load capacitance 350PF.

### ⑦ Low-cut Button (LOW CUT)

When this button is pressed, the LED lights up cutting out ultra-low range noise. Press again to cancel the setting. This function is intended to be used when the speaker woofer moves a lot due to, for example, curve of a record.

### ⑧ Gain Low Button (GAIN LOW)

When this button is pressed, the LED lights up enabling you to lower the output level by 10dB. Press again to cancel the setting. About 5 seconds is required for sound to be output after the button operation. This function is intended to be used when sound is distorted because input goes over the maximum allowable input level (headroom) of the connected preamplifier or other devices.

### ⑨ Degauss Button (DEGAUSS)

When this button is pressed, the LED lights up short-circuiting input. Press again to cancel the setting. Playing a record with the input short-circuited for several seconds is beneficial because the cartridge can be degaussed. This can also work as a mute function when putting down the needle on a record.

### ⑩ Ultra-low Range Amplification Limit Frequency Selector Dial (LOW LIMIT)

Select an ultra-low range amplification limit frequency. When the RIAA parameter is selected, the LED lights up in green. About 5 seconds is required for sound to be output after the button operation.

### ⑪ Low Range Amplification Frequency Selector Dial (TURNOVER)

Select a low range amplification frequency. When the RIAA parameter is selected, the LED lights up in green. About 5 seconds is required for sound to be output after the button operation. When FLAT is selected using the LOW LIMIT Dial ⑩, operation of the TURNOVER Dial is disabled and the low range amplification frequency will remain set to FLAT regardless of what you select.

### ⑫ High-range Attenuation Frequency Selector Dial (ROLLOFF)

Select a high-range attenuation frequency. When the RIAA parameter is selected, the LED lights up in green. About 5 seconds is required for sound to be output after the button operation.

### ⑬ MC Load Resistance Selector Dial (MC LOAD)

Select a load resistance suitable for the MC cartridge used. The dial operation is disabled when in the MM position or when OPT is selected. About 5 seconds is required for sound to be output after the button operation.

### ⑭ Input Selector Dial (INPUT)

Up to 4 record players (tone arms) can be connected to the unit. Use this dial to select the input. About 5 seconds is required for sound to be output after the button operation.

- BAL : MC balanced input
- 1, 2 : Unbalanced input (MC/MM)
- OPT : Optoelectronic cartridge input

# Rear Panel Names and Functions

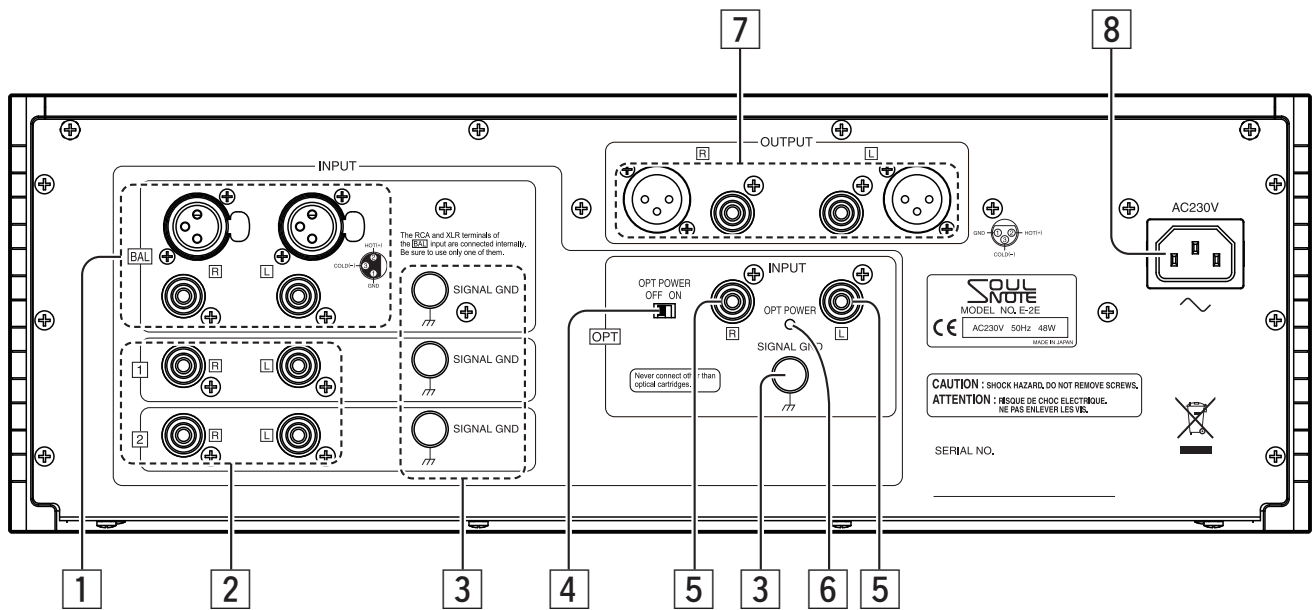

## 1 MC Balanced Input Terminals (BAL)

These are the MC balanced input terminals. Although there are XLR terminals and RCA terminals, as both are connected internally, connect to only one type at a time. For RCA balanced inputs, use double-shielded RCA cables (with grounding wire).

## 2 Unbalanced Input Terminals (1, 2)

These are the MC and MM cartridge input terminals.

## 3 Grounding Terminals (SIGNAL GND)

Connect the grounding wire of each record player to these terminals.

## 4 Optoelectronic Cartridge Power Switch (OPT POWER)

This is the power switch of the optoelectronic cartridge input terminal. Set this to ON when connecting an optoelectronic cartridge. When this switch is set to ON, the OPT POWER LED lights up.

## 5 Optoelectronic Cartridge Input Terminals (OPT)

These are optoelectronic cartridge input terminals.

### Note:

- As DC voltage is applied, never connect anything other than optoelectronic cartridges to these terminals.

## 6 OPT POWER LED

When the Optoelectronic Cartridge Power Switch is set to ON, DC voltage is applied to the Optoelectronic Cartridge Input Terminals and this LED lights up.

## 7 Output Terminals

Connect these to the line input terminals of devices such as a preamplifier and pre-main amplifier.

### Balanced output terminal

Connect an XLR cable to these terminals.

### Unbalanced output terminal

Connect an RCA cable to these terminals.

### Note:

- For sound quality reasons, do not use balanced and unbalanced outputs at the same time. Also, even when not in use, merely connecting results in a capacitance load which can adversely affect the sound quality. Using balanced and unbalanced outputs at the same time will not cause a malfunction.

## 8 AC Inlet

Connect to a 230 V AC wall outlet (mains) with the supplied power cable.



## About EQ Curves of Old Records

It is known that quite a wide variation in EQ curves were used for the recording of SP records and original LP records prior to RIAA curve unification and for a while after unification. In order to accommodate the EQ curves of such records, the unit is provided with an Old EQ function.

Although record labels used a wide variation in EQ curves over different time periods, the following EQ Curve List lists the record labels with their Year (indicating time period) and Curve name, and provides parameters of the unit to accommodate LOW LIMIT, TURNOVER, and ROLL-OFF for each record label.

For record labels with rows for multiple time periods, the rows are arranged from oldest to newest. Find the recording year for the record label of the record you want to play, confirm the applicable EQ curve, and set the parameters by using the Frequency Selector Dials. In some cases, it is not possible to accurately accommodate an EQ curve.

### Note:

- Up until the 1970s, there are records that were not recorded with the RIAA curve.
- Re-released or re-mastered records typically use the RIAA curve.
- There are various views and opinions regarding these EQ curves.
- As for records that were not recorded with the RIAA curve, in most cases, there is a high chance that they were recorded in reverse phase. (Except for the Phillips record label).

### EQ Curve List

Label	Year	Curve Name	LOW LIMIT	TURNOVER	ROLL-OFF
Aeolian	~ 1919	Acoustic	50	630	1.59
Allegro	1948 ~ 1956	LP	100	500	1.59
Allied	~ 1958	LP	100	500	1.59
American Recording Society	~ 1958	AES	50	390	2.59
Angel	~ 1952	Old Orthophonic	50	500	2.59
Argo		American 78	50	250	6.89
		RIAA	50	500	2.12
Arizona	~ 1955	Capitol	50	390	2.59
Atlantic	~ 1953	NAB	71	500	1.59
Audio Fidelity		NAB	71	500	1.59
Audiophile	1948 ~ 1958	Audiophile	50	500	6.89
	1954 ~ 1958	MGM	50	500	2.59
Bach Guild		LP	100	500	1.59
		NAB	71	500	1.59
Banner		LP	100	500	1.59
Bartok	~ 1952	LP	100	500	1.59
	1952 ~ 1953	AES	50	390	2.59
		Bartok	100	630	1.59
Berliner		Acoustic	50	630	1.59
Blue Note	~ 1955	AES	50	390	2.59
Boston	~ 1958	LP	100	500	1.59
Broadcast		American 78	50	250	6.89
Brunswick	~ 1951	Modern 78	50	630	6.89
	1951 ~ 1955	AES	50	390	2.59
Caedmon		Bartok	50	630	1.59
Canyon		AES	50	390	2.59
Capitol	~ 1951	American 78	50	250	6.89
	1948 ~ 1954	NAB	71	500	1.59
	1951 ~ 1955	Capitol	50	390	2.59

Label	Year	Curve Name	LOW LIMIT	TURNOVER	ROLL-OFF
Capitol-Cetra	1948 ~ 1954	NAB	71	500	1.59
	1947 ~ 1955	Capitol	50	390	2.59
Cetra-Soria		European 78	50	250	FLAT
	~ 1961	LP	100	500	1.59
Clarion		Acoustic	50	630	1.59
Colosseum	~ 1954	NAB	71	500	1.59
Columbia Large blue		Acoustic	50	630	2.59
Columbia Runoff grooves		Acoustic	50	630	2.59
Columbia	~ 1940	American 78	50	250	6.89
	1940	Columbia 78	50	250	1.59
	1948 ~ 1953	NAB	71	500	1.59
	1947 ~ 1955	LP	100	500	1.59
Concert Hall AES		AES	50	390	2.59
Concert Hall British	~ 1956	London	100	500	3.18
Concert Hall American	~ 1954	LP	100	500	1.59
Contemporary		AES	50	390	2.59
		NAB	71	500	1.59
Cook		Cook	50	500	1.59
Coral	~ 1958	NAB	71	500	1.59
Decca American		Modern 78	50	500	FLAT
	~ 1951	FFRR 78	50	250	FLAT
	1949 ~ 1951	London	100	500	3.18
	1951 ~ 1953	AES	50	390	2.59
	1953 ~ 1955	NAB	71	500	1.59
Decca British	~ 1944	European 78	50	250	FLAT
	1944 ~ 1956	FFRR 78	50	250	FLAT
	1949 ~ 1956	London	100	500	3.18
Decca European	~ 1944	European 78	50	250	FLAT
	1944 ~ 1950	FFRR 78	50	250	FLAT
	1949 ~ 1954	Telefunken	50	390	FLAT
	1954 ~ 1962	CCIR	50	390	3.18
	1954 ~ 1962	RIAA	50	500	2.12
Dial	1948 ~ 1954	LP	100	500	1.59
Diva		Acoustic	50	630	1.59
Dot	~ 1958	AES	50	390	2.59
Edison	1916 ~ 1926	Acoustic	50	630	1.59
Elektra		AES	50	390	2.59
		Bartok	50	630	1.59
		RIAA	50	500	2.12
Emerson	1916 ~ 1918	Acoustic	50	630	1.59
EMI-Angel	~ 1952	Old Orthophonic	50	500	2.59
EMI-HMV	1909 ~ 1926	Acoustic	50	630	2.59
	1927 ~	European 78	50	250	FLAT
	1951 ~ 1954	NAB	71	500	1.59
	1954 ~	HMV	50	500	1.59
EMS	1951 ~ 1956	AES	50	390	2.59
Epic	1948 ~ 1954	LP	100	500	1.59

Label	Year	Curve Name	LOW LIMIT	TURNOVER	ROLL-OFF
Esoteric		AES	50	390	2.59
Exclusive		FFRR 78	50	250	FLAT
Festival	~ 1955	LP	100	500	1.59
Folkways	~ 1955	LP	100	500	1.59
Fonotipia	1904 ~ 1930	Acoustic	50	630	1.59
Gennett		Acoustic	50	630	1.59
Good Time Jazz		NAB	71	500	1.59
		AES	50	390	2.59
		RIAA	50	500	2.12
Gramophone & Typewriter	~ 1908	Acoustic	50	630	1.59
Handel Society	~	LP	100	500	1.59
His Master' s Voice	~ 1926	Acoustic	50	630	2.59
	1927 ~	European 78	50	250	FLAT
	1951 ~ 1954	NAB	71	500	1.59
	1954 ~	HMV	50	500	1.59
Kapp		Kapp	50	630	1.59
Kendall	~ 1958	NAB	71	500	1.59
L' Oiseau-Lyre	~ 1954	London	100	500	3.18
London		LP	100	500	1.59
		London	100	500	3.18
London International		LP	100	500	1.59
		London	100	500	3.18
Lyrichord	1948 ~ 1951	LP	100	500	1.59
	1951 ~	NAB	71	500	1.59
MacGregor	~ 1965	American 78	50	250	6.89
Majestic	~ 1918	Acoustic	50	630	1.59
Mercury	~ 1951	American 78	50	250	6.89
	1951 ~ 1954	AES	50	390	2.59
MGM	~ 1952	MGM	50	500	2.59
	~ 1952	NAB	71	500	1.59
Music Treasures		LP	100	500	1.59
Musica	~ 1925	Acoustic	50	630	1.59
New	~ 1954	LP	100	500	1.59
Nixa AES	~ 1955	AES	50	390	2.59
Nixa NAB	~ 1955	NAB	71	500	1.59
Nixa	~ 1955	LP	100	500	1.59
Nocturne		AES	50	390	2.59
Oceanic	~ 1958	LP	100	500	1.59
Odeon	~ 1925	Acoustic	50	630	1.59
Oiseau-Lyre	~ 1954	London	100	500	3.18
Okeh	1918 ~ 1926	Acoustic	50	630	1.59
	1926 ~ 1941	American 78	50	250	6.89
	1941	Modern 78	50	390	6.89
Opera Disc	~ 1925	Acoustic	50	630	1.59
Overtone		NAB	71	500	1.59
Oxford		LP	100	500	1.59
Pacific Jazz		AES	50	390	2.59
	~ 1953	Pacific Jazz	100	500	2.59

Label	Year	Curve Name	LOW LIMIT	TURNOVER	ROLL-OFF
Paramount	~ 1918	Acoustic	50	630	1.59
Pathé	~ 1926	European 78	50	250	FLAT
	1926 ~ 1931	Acoustic	50	630	1.59
Period	1949 ~ 1953	NAB	71	500	1.59
Philharmonia		AES	50	390	2.59
Philips	~ 1953	Philips	50	390	6.89
Polydor		Acoustic	50	630	1.59
Polymusic	~ 1958	NAB	71	500	1.59
Rachmaninoff Society		LP	100	500	1.59
RCA	1931 ~ 1947	American 78	50	250	6.89
	1941 ~ 1952	Old RCA	50	630	6.89
	1947 ~ 1951	RCA	50	630	2.59
	1950 ~ 1952	Old Orthophonic	50	500	2.59
Remington		NAB	71	500	1.59
Renaissance	1949 ~ 1952	LP	100	500	1.59
	1952 ~ 1954	Pacific Jazz	100	500	2.59
Riverside	~ 1955	AES	50	390	2.59
Stradivari	~ 1958	LP	100	500	1.59
Technichord		Technichord	50	630	2.59
Telefunken	1945 ~ 1950	FFRR 78	50	250	FLAT
	1951 ~ 1953	Telefunken	50	390	FLAT
	1954 ~ 1962	CCIR	50	390	3.18
Tempo		American 78	50	250	6.89
	1948 ~ 1953	LP	100	500	1.59
	1954 ~	NAB	71	500	1.59
Theme		American 78	50	250	6.89
Transradio		LP	100	500	1.59
Urania		AES	50	390	2.59
	~ 1954	LP	100	500	1.59
Vanguard	1948 ~ 1951	LP	100	500	1.59
		NAB	71	500	1.59
		AES	50	390	2.59
Victor	1909 ~ 1926	Acoustic	50	630	2.59
	1926 ~ 1931	American 78	50	250	6.89
Vocalion	~ 1919	Acoustic	50	630	1.59
Vox AES		AES	50	390	2.59
Vox	1948 ~ 1951	LP	100	500	1.59
	1951 ~ 1954	NAB	71	500	1.59
Westminster AES		AES	50	390	2.59
Westminster	~ 1955	LP	100	500	1.59
Zonophone		Acoustic	50	630	1.59

## Balanced Input/Output

The XLR Connector is used for Balanced Input/Output. There are two types of connection, "European Type" and "USA Type".

This unit adopts European Type of XLR connector. If the connecting equipment has the "USA Type" of XLR then audio signal becomes antiphase. In this case, swap pin 2 and pin 3 of XLR connector (INPUT or OUTPUT) to work same as European Type.

### 1. European Type (adapter for this unit)

(pin 2 = HOT, pin 3 = COLD)



### 2. USA Type

(pin 2 = COLD, pin 3 = HOT)

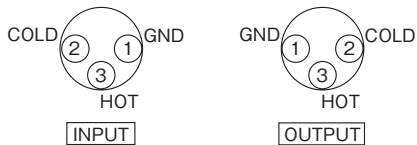

## Attaching the Spike Pins

By replacing the feet with the supplied spike pins, you can tune the audio quality. Point grounding makes the sound focus and auditory lateralization sharper. Furthermore, the audio quality can be subtly tuned by changing the material of the surface on which this unit is installed.

### Note:

- When using the spike pins, be careful as the installation surface such as the surface of a table, shelf, etc., may become damaged.

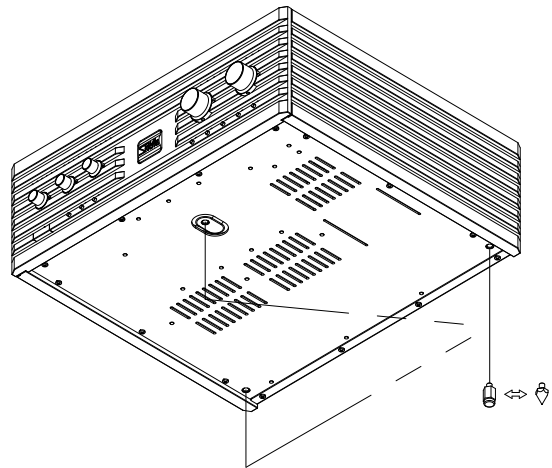

## Aging

The Audio products including Speaker system need the aging in general. Especially many sensitive parts to get high quality sound are used in this unit, the aging is very important factor.

## Troubleshooting

### No sound is output.

- Check that the power of the main unit is on.
- Check that the appropriate input source is selected.
- Check the connections of the external devices.
- Check that the power of the external devices is on.

## Maintenance

When the unit has become dirty, wipe it clean using a soft cloth. To remove stubborn stains, dilute some dish-washing liquid in 5 or 6 times as much water, soak a soft cloth in the solution, wring it out well, wipe away the stains, and then wipe the surfaces dry with a dry cloth. Never use alcohol, paint thinners, benzine, insecticides or other volatile substances since they may mar or remove the surface gloss.

Bear in mind that rubbing surfaces with a chemical cleaning cloth or leaving such a cloth in contact with a surface for an extended time may result in deterioration.

## Specifications

RIAA deviation .....	±0.2dB
Input sensitivity .....	MC: 0.4 mV MM: 4 mV OPT: 50 mV
Load resistance ....	MC: 3, 10, 30, 100, 300, 1K ohm MM: 47 kohm
Load capacitance .....	MM: 100, 200, 350 PF
Gain .....	MC: 72dB (1 kHz) MM: 52dB (1 kHz) OPT: 30dB (1 kHz)
Rated output	
Unbalanced output .....	1.4 Vrms
Balanced output .....	2.8 Vrms
Equalizer frequency	
ROLL-OFF (kHz):	1.59 / 2.12(RIAA) / 2.59 / 3.18 / 6.89 / FLAT
TURNOVER (Hz):	250 / 390 / 500(RIAA) / 630
LOW LIMIT (Hz):	50(RIAA) / 71 / 100 / 125 / 150 / FLAT
Power voltage.....	230 V AC , 50 Hz
Power consumption.....	48 W
Maximum external dimensions	
	430 (W) x 160 (H) x 410 (D) mm
Weight .....	20 kg





**CSR, Inc.**

<https://www.soulnote.link/>